

BAUER MC 128

Duty-Cycle Crane

MC Line



Dimensions Base Machine

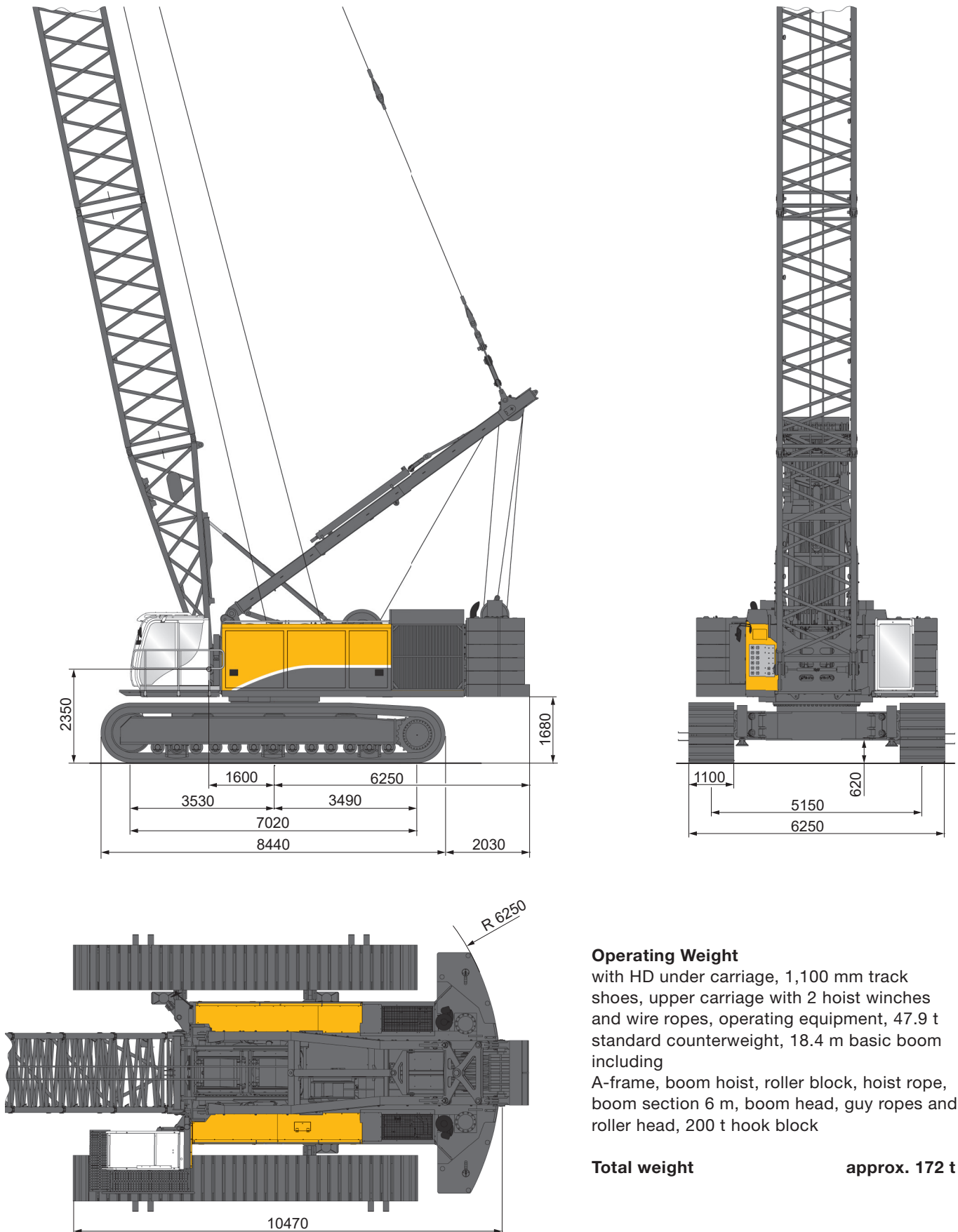

Operating Weight

with HD under carriage, 1,100 mm track shoes, upper carriage with 2 hoist winches and wire ropes, operating equipment, 47.9 t standard counterweight, 18.4 m basic boom including A-frame, boom hoist, roller block, hoist rope, boom section 6 m, boom head, guy ropes and roller head, 200 t hook block

Total weight

approx. 172 t

Upper carriage

Modular, torsion-proof, precision-welded construction, designed for high continuous load, pre-equipped for additional applications

- Variable counterweight concept, simple mounting/removal system for easy transport
- 4 headlights
- Walkways to the front and side of the cab
- Excellent accessibility of all major components for service procedures

Counterweight – bearing plate	1 x 16.7 t
Add-on counterweight (max. 6 x)	2 x 2.6 t
Additional counterweight (optional)	2 x 7.8 t
Counterweight extendable	max. 63.5 t

Engine

CAT diesel engine	C 27	C 27	C 32	
Nominal output	kW	709	709	839
Operating speed	rpm	1,800	1,800	1,800

Exhaust emission standard

EPA/CARB	Tier 2	Tier 4 final	Tier 2	
EU 2016/1628	Stage V			
	China St. III			
Diesel tank volume	l	1,650	1,650	1,650

Hydraulic system

Modern, high-performance hydraulic system with energy-saving flow control on demand and power management system in multiple-circuit technology

Flow rates

Main pumps	3 x 436 l/min
Main pumps (optional)	2 x 565 l/min
Auxiliary pump	1 x 328 l/min
Swing pump (closed circuit)	1 x 407 l/min
Mooring pumps	2 x 127 l/min
Fan drive	2 x 101 l/min
Hydraulic pressure	320 bar
Hydraulic tank capacity	1,000 l

- Closed circuits for main winches
- Open hydraulic circuits for additional consumers (optional)
- Closed hydraulic system for slewing gear
- Additional gear pumps for cooling and control systems
- Electro-hydraulic load sensing control
- Cleaning of hydraulic oil by means of large-dimensioned return oil filters, leak oil filters and pressure filters in the pilot control system
- Cooling system with high power reserve for working under permanent load even in difficult climate conditions

Load hoist assemblies

Low-maintenance, compact duty-cycle crane winches, powered by controlled hydraulic adjustable motors via integrated planetary gears.

Main winch 1	350 kN
Main winch 2	350 kN
Rope capacity 3 layers	144.2 m
Rope diameter	36 mm
Drum diameter	836 mm
Rope speed	max. 74 m/min

Boom hoist assembly

Adjustment via winch

Line pull of boom hoist winch	approx. 170 kN
Rope diameter	24 mm

- Depth control via incremental indicator/absolute sensor
- Load measurement with slack-rope switch-off
- Rope winding device for winch 1 and winch 2

Swing gear

Slew ring driven by axial piston motor and planetary gear

- 2 swing gears
- Slewing and dynamic braking in closed circuit for sensitive control
- Rotation speed can be pre-selected in steps up to 3 rpm
- Hydraulically activated multiple disk holding brake
- Extra large slewing ring, externally toothed
- Low-maintenance slew gear

Under carriage

Rigid crawler under carriage with wide car body and hydraulically locked crawler assemblies

- 4 access ladders on the crawler

Type	UW 250 AC
Travel speed	approx. 1.0 km/h
Crawler type	B 9 HD
Track shoe width	1,100 mm
Track width	5,150 mm
Crawler width	6,250 mm
Crawler length	8,440 mm

Control System

Programmable microprocessor control system with electro-proportional pre-control

- Clearly arranged control panel for crane functions, located to the right-hand side of the operator's seat
- Two joysticks at the operator's seat for all functions or double-T stick for two-rope grab control
- Two foot pedals for control of under carriage
- Foot pedals for control of freefall brake, pre-selectable secured or unsecured mode

B-Drive

The B-Drive is a central operating and visualization system

- B-Drive combines adjustable potentiometer values on one display
- Ergonomic positioning of the display on the right column of the operator's cab

B-Tronic

The BAUER B-Tronic system allows completion of construction tasks in a reliable and accurate manner, even under extreme operating conditions.

- The high-resolution touchscreen display ensures excellent user-friendliness
- The display can be optimally adapted to the operating situation and the amount of light present by changing the brightness level, the color scheme and the day/night mode
- The main parameters can be viewed at a glance
- Recording of all production data
- Easy trouble shooting for service operations

Boom

Robust tubular lattice boom with thick-walled boom tubes, specifically designed for applications in specialist foundation engineering where high long-term dynamic loads occur

- Basic boom consists of an A-frame, hoist winch, hoist rope, boom foot

- The boom is designed for Bauer hose drum systems
- Boom extensions and boom head according to application

Operator's Cab

Comfort cab, FOPS certified

- Resiliently mounted, with exceptional sound suppression
- Excellent all-round visibility of the working area
- Sun blind
- Sliding door with sliding window
- Front windshield and side windows made of laminated safety glass
- Tinted skylight and side windows with sun protection foil
- Wiper/washer system for front windshield and skylight
- Infinitely variable cab heating system
- Stone guard
- First aid box
- Radio with MP3, USB and Bluetooth hands-free Speakerphone
- Camera system with on-screen display in the cab

Comfortable operator's seat

Mechanically sprung

- Weight and height adjustable
- Inclination adjustment
- Horizontally adjustable
- Headrest and adjustable armrests
- Document compartment
- Fully hydraulic cabin tilting system for effortless working with large boom lengths
- For easy transport cabin can be retracted in front of upper carriage

Automatic air conditioning system

Fully automatic controlled air conditioning system with comfortable control panel

- Selection manual/automatic mode
- Manual changing from degrees Celcius to Fahrenheit possible

Energy-Efficient Power EEP

The EEP contains the following modifications:

- Variable and intelligent cooler and fan control
- Reduction in flow rate losses as a result of optimized hydraulic components
- Smart ECO mode of the Diesel engine
- Closed hydraulic circuits for main winch operation



Optional Equipment

- Rope roller guide system for main winches
- Tensile load measurement via redundant load measuring sockets
- Winch synchronization for main winches
- Electronic load moment limitation for hoisting device operation, user interface integrated in B-Tronic
- Different roller heads for various applications
- Set of ropes for different applications
- Hydraulic and electronic equipment kits for various applications, such as Cutter systems, two-rope grabs, hanging leaders, hydraulic hammers, depth vibrators and rotary heads
- Quick connection system for the crawlers with hydraulic quick couplings, assembling tools and lifting gear
- Rope pull-in winch
- Hydraulic counterweight mover with hydraulic ballast lock
- Independent cab heater with timer
- Electric fuel pump for diesel tank
- Aircraft warning light
- Anemometer
- Bauer GCS data recording system for hydraulic grabs
- Central lubrication system
- Counterweights for various types of applications
- Adapter for casing oscillator on under carriage
- Walkways on the upper carriage for various types of applications
- Access ladder to upper carriage
- Special coating available on request
- Sun protection systems in various designs
- Working at height system for boom walkway
- On top hand rails – upper carriage
- Rope fix point with overload protection
- Fire extinguishing system
- DTR module
- Rear frame for additional power packs
- Protective ventilation system

Equipment with Trench Cutter Systems BC



Hose drum system HDS 120
Max. cutting depth 120 m
Max. load 56 t

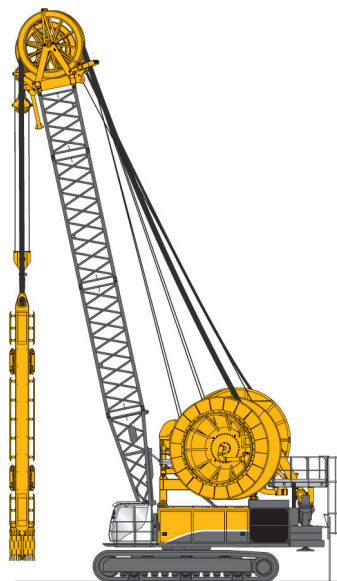

Hose drum system HDS 150 / 250
Max. cutting depth 150 m / 250 m
Max. load 68 t / 62 t

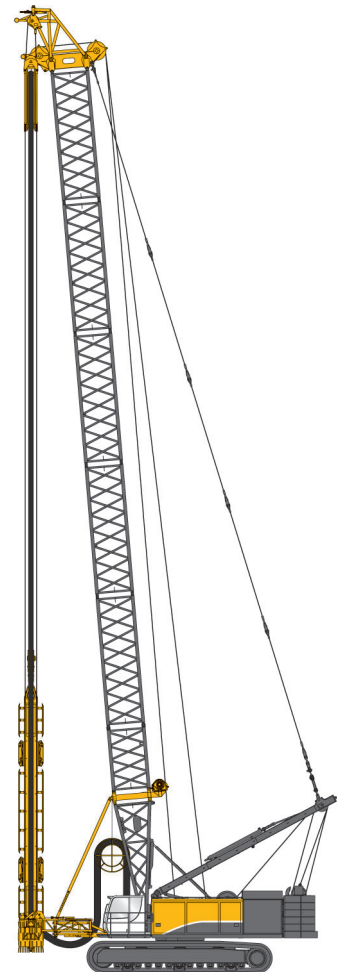

Hose tensioning system HTS 70
Max. cutting depth 70 m*
Max. load 45 t

* lower depths with higher hook loads on request

Duty-Cycle Crane Operation – Load Chart

Counterweight 47.9 t, boom lengths from 21.4 to 42.4 m, loads in t

Radius (m)	Boom length (m)							
	21.4	24.4	27.4	30.4	33.4	36.4	39.4	42.4
6.0	65.0	65.0	65.0	65.0	65.0	65.0	65.0	65.0
7.0	65.0	65.0	65.0	65.0	65.0	65.0	65.0	65.0
8.0	65.0	65.0	65.0	65.0	65.0	65.0	65.0	65.0
9.0	65.0	65.0	65.0	65.0	65.0	65.0	65.0	65.0
10.0	65.0	65.0	65.0	65.0	64.4	63.4	62.3	61.2
11.0	59.0	58.2	57.5	56.6	55.7	54.7	53.7	52.6
12.0	51.9	51.2	50.5	49.6	48.8	47.8	46.9	45.9
13.0	46.2	45.6	44.9	44.1	43.3	42.3	41.5	40.5
14.0	41.5	40.9	40.2	39.5	38.7	37.8	37.0	36.0
15.0	37.6	37.0	36.4	35.6	34.9	34.0	33.2	32.3
16.0	34.3	33.7	33.1	32.4	31.6	30.8	30.0	29.1
17.0	31.4	30.9	30.2	29.5	28.8	28.0	27.3	26.4
18.0	28.9	28.4	27.8	27.1	26.4	25.6	24.9	24.1
19.0	26.7	26.2	25.6	25.0	24.3	23.5	22.8	22.0
20.0	24.7	24.3	23.7	23.1	22.4	21.7	20.9	20.1
21.0		22.5	22.0	21.4	20.7	20.0	19.3	
22.0		21.0	20.5	19.9	19.2	18.5	17.8	
23.0		19.6	19.1	18.5	17.8	17.2	16.5	
24.0		18.3	17.8	17.3	16.6	16.0	15.3	
25.0			16.7	16.1	15.5	14.9		
26.0			15.6	15.1	14.5	13.8		
27.0			14.7	14.1	13.6	12.9		
28.0			13.8	13.3	12.7	12.1		
29.0				12.5	11.9			
30.0				11.7	11.2			
31.0					10.5			
32.0					9.8			

Notes:

1. The specified loads are maximum values and must not be exceeded.
2. The rated loads are valid for a planar, firm plane.
3. The rated loads are valid for a 360° swing angle.
4. The rated loads are valid for maximum under carriage track width.
5. The rated loads do not exceed 75 % of the tipping load.
6. The weights of lifting accessories and ropes are part of the permissible total load.
7. When lifting loads that exceed the maximum pulling force of a winch it must be ensured that no single winch is overloaded.
8. During operation with a mechanical two-rope grab, the maximum pulling force of a single winch – considering the rope layer – must not be exceeded.
9. The specified values are for information purposes only. The actual values can be found in the documentation supplied with the machine.

Duty-Cycle Crane Operation with Mechanical Two-Rope Grab

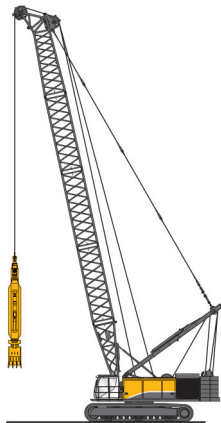

Diaphragm wall grab

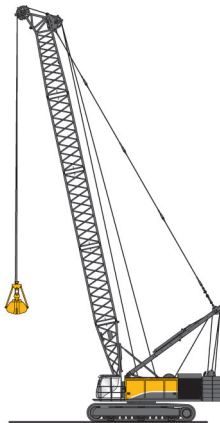

Two-rope grab

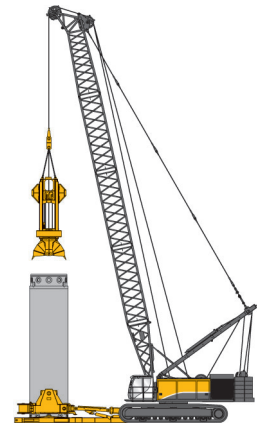

Grab with casing oscillator

Base Machine with Hydraulic Power Supplied by the On-Board Hydraulic System

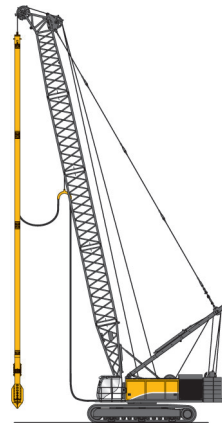

Depth Vibrator TR

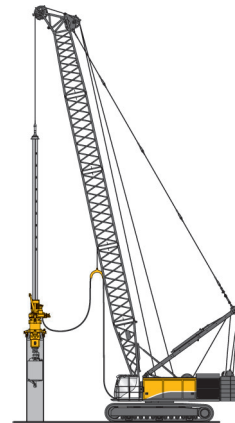

Fly Drill BFD

Dynamic Soil Compaction (BDC)

Counterweight 47.9 t, boom lengths from 21.4 to 42.4 m, loads in t

Radius (m)	Boom length (m)							
	21.4	24.4	27.4	30.4	33.4	36.4	39.4	42.4
8.0	70.0	70.0	67.8	67.8	62.9	62.9	59.0	59.0
9.0	70.0	70.0	65.2	65.2	60.5	60.5	56.9	56.9
10.0	67.9	67.2	62.9	62.9	58.2	58.2	54.7	54.7
11.0	59.0	58.2	57.5	56.6	55.7	54.7	52.7	52.6
12.0	51.9	51.2	50.5	49.7	48.8	47.9	46.9	45.9
13.0	46.2	45.6	44.9	44.1	43.3	42.4	41.5	40.5
14.0	41.5	40.9	40.2	39.5	38.7	37.9	37.0	36.0
15.0	37.6	37.0	36.4	35.6	34.9	34.1	33.2	32.3
16.0	34.3	33.7	33.1	32.3	31.6	30.8	30.0	29.1

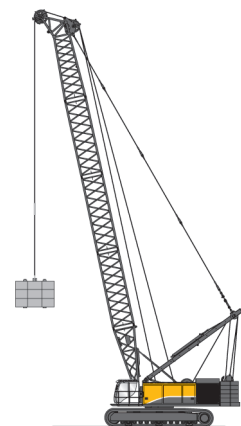

Dynamic Soil Compaction (BDC)

Notes:

1. The rated loads are valid for a planar, firm plane.
2. The rated loads are valid for a 360° swing angle
3. The rated loads are valid for maximum under carriage track width.
4. The specified values are for information purposes only. The actual values can be found in the documentation supplied with the machine.

Equipment for Lifting Operation

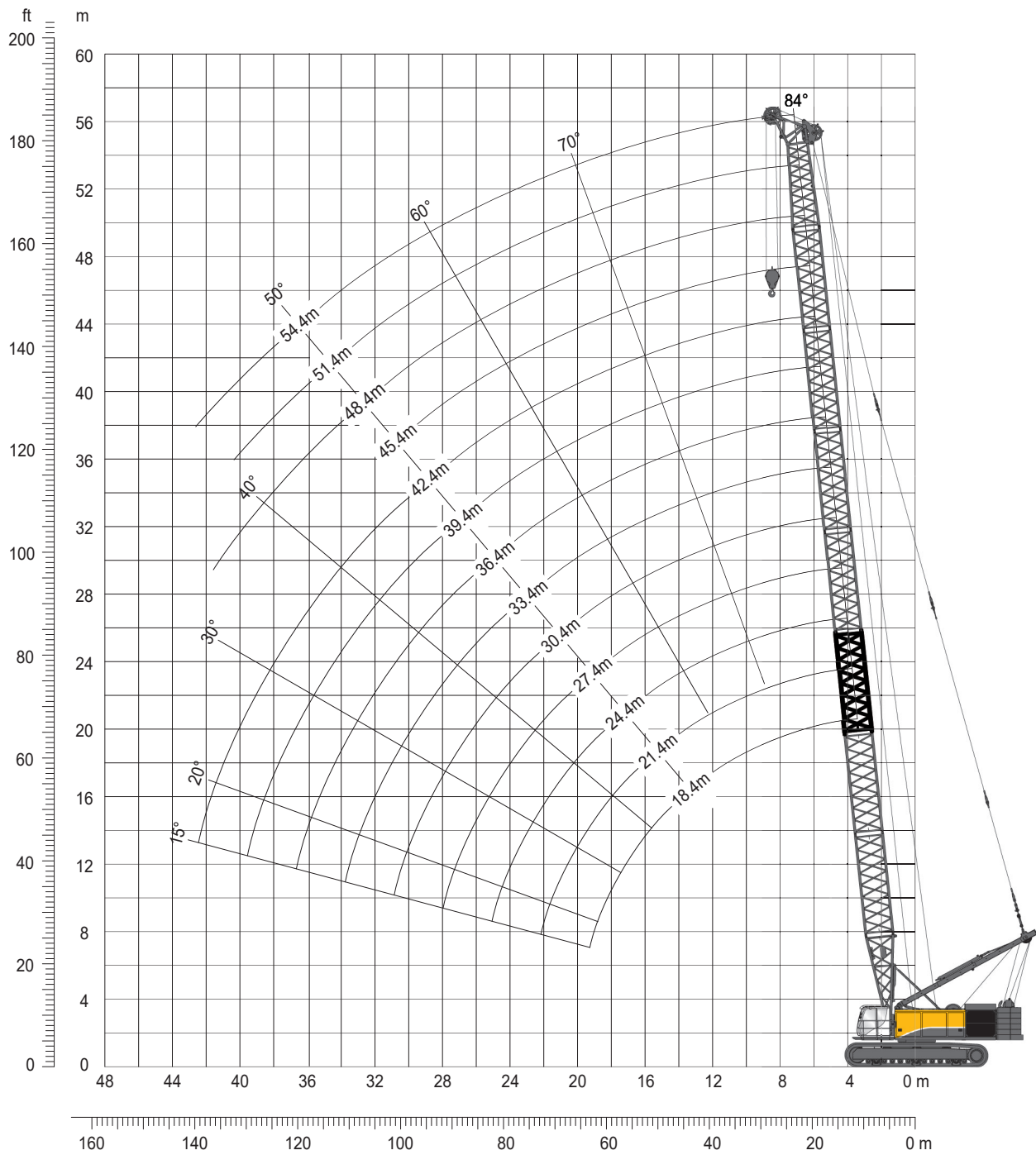

Boom configurations

	Length (m)	Total boom length (m)												
		18.4	21.4	24.4	27.4	30.4	33.4	36.4	39.4	42.4	45.4	48.4	51.4	54.4
Boom foot section	5.6	1	1	1	1	1	1	1	1	1	1	1	1	1
Boom section	3.0		1		1		1		1		1		1	
Boom section	6.0	1	1	2	2	3	3	4	4	5	5	6	6	7
Upper boom section	6.8	1	1	1	1	1	1	1	1	1	1	1	1	1

Lifting Operation – Load Chart

Boom length from 18.4 to 54.4 m, loads in t

Counterweight t	42.7			47.9			53.1				63.5	
	Boom length (m)											
Radius (m)	18.4	21.4	24.4	27.4	30.4	33.4	36.4	39.4	45.4	51.4	54.4	
4.1	200.0											
4.3		165.7										
4.6			166.2									
4.8				169.6								
5	155.5	155.8	157.2	159.9	159.6							
5.2						146.8						
5.4							134.1					
5.6								115.1				
6	139.0		134.4	128.5	130.5	125.1	120.0	111.7	91.9			
6.4										65.8	46.5	
6.6											46.5	
7	113.6	140.6	111.3	107.0	109.3	105.2	101.3	97.6	86.0	62.9	45.4	
8	95.7	115.8	94.6	91.2	93.6	90.4	87.3	84.3	80.2	58.1	42.5	
9	81.3	98.0	82.0	79.2	81.6	78.9	76.4	73.9	74.5	53.4	39.6	
10	69.1	84.7	72.1	69.8	72.0	69.7	67.6	65.4	69.0	49.0	36.8	
11	59.8	73.5	63.5	62.1	64.3	62.3	60.4	58.5	61.9	44.9	34.1	
12	52.5	63.6	55.8	55.5	57.8	56.1	54.4	52.7	55.9	41.4	31.5	
13	46.6	55.9	49.5	49.2	52.2	50.8	49.4	47.8	50.8	38.4	29.1	
14	41.7	49.6	44.3	44.0	46.7	46.3	45.0	43.6	46.4	35.8	26.8	
15	37.6	44.5	40.0	39.6	42.1	41.7	41.2	39.9	42.6	33.7	24.8	
16	34.1	40.1	36.3	35.9	38.2	37.8	37.4	36.7	39.2	31.8	22.9	
17	31.0	36.4	33.1	32.7	34.8	34.4	34.0	33.6	36.2	30.0	21.2	
18	28.3	33.2	30.3	30.0	31.9	31.4	31.1	30.6	33.5	28.5	19.6	
19	25.9	30.4	27.8	27.5	29.3	28.9	28.5	28.0	31.1	27.0	18.2	
20		27.9	25.6	25.3	27.0	26.6	26.2	25.7	28.7	25.5	16.9	
21		25.7	23.7	23.4	24.9	24.5	24.2	23.7	26.4	24.0	15.6	
22		23.7	21.9	21.6	23.1	22.7	22.3	21.9	24.4	22.5	14.4	
23		21.9	20.3	20.1	21.4	21.0	20.7	20.2	22.6	21.0	13.2	
24			18.8	18.6	19.9	19.5	19.2	18.7	20.9	19.8	12.1	
25			17.4	17.3	18.6	18.1	17.8	17.3	19.4	18.4	11.1	
26				16.1	17.3	16.9	16.5	16.1	18.0	17.0	10.5	
27				14.9	16.1	15.7	15.4	14.9	16.7	15.8	10.2	
28				13.8	15.0	14.6	14.3	13.8	15.5	14.6	10.0	
29					14.0	13.6	13.3	12.8	14.5	13.5	9.8	
30					13.0	12.7	12.4	11.9	13.4	12.5	9.6	
31					12.1	11.8	11.5	11.1	12.5	11.5	9.4	
32						11.0	10.7	10.3	11.6	10.7	9.2	
33						10.2	9.9	9.5	10.8	9.8	9.0	
34						9.4	9.2	8.8	10.0	9.1	8.6	
35							8.5	8.1	9.3	8.3	7.9	
36							7.9	7.5	8.6	7.7	7.2	
37							7.2	6.9	8.0	7.0	6.6	
38								6.3	7.4	6.4	5.9	
39								5.7	6.8	5.8	5.4	
40								5.2	6.2	5.3	4.8	
41									5.7	4.8	4.3	
42									5.2	4.3	3.8	
43									4.7	3.8	3.3	
44									4.2	3.3	2.8	
45									3.7	2.9	1.8	
46										2.5		
47										2.1		
48										1.7		
49										1.3		

Notes re. load chart on page 9:

1. The rated loads are valid for a planar, firm plane.
2. The rated loads are valid for a 360° swing angle
3. The rated loads are valid for maximum under carriage track width.
4. The specified values are for information purposes only. The actual values can be found in the documentation supplied with the machine.

G = Weight
B = Width

Weight data are approximate, optional equipment may change the overall weight and dimensions.

Base machine

G = 63.5 t

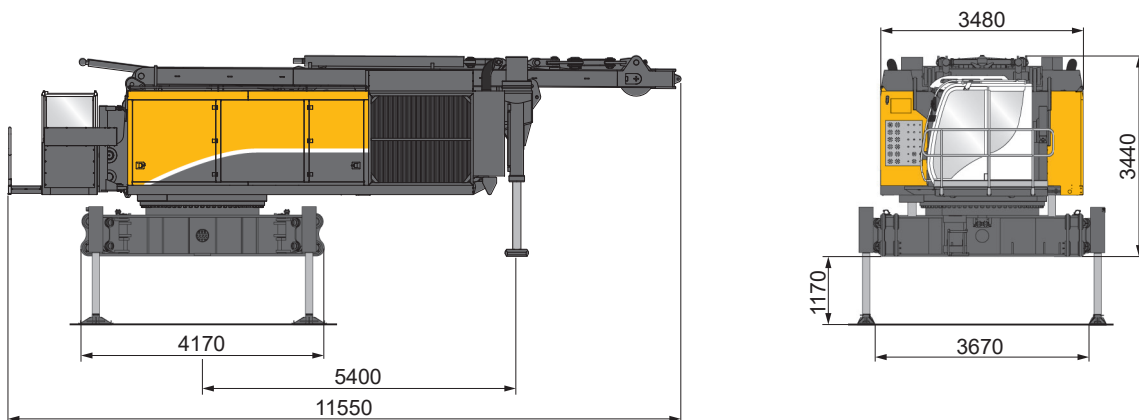

Crawlers UW 250 AC

G = 2 x 23 t

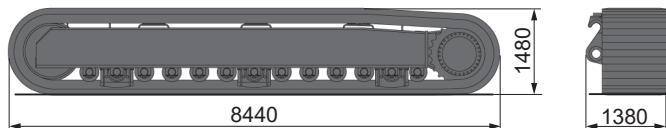

Counterweights

Counterweight bearing plate
G = 16.7 t

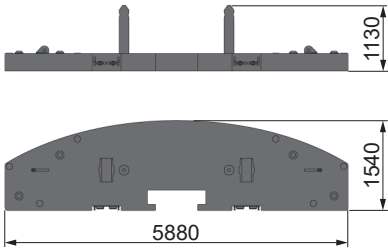

Additional counterweight
G = 2 x 7.8 t

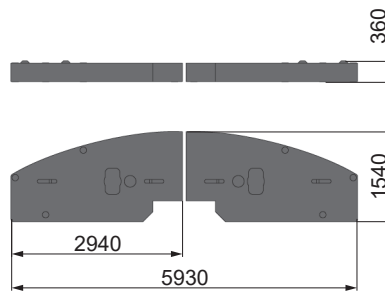

Add-on counterweight
G = 2 x 2.6 t

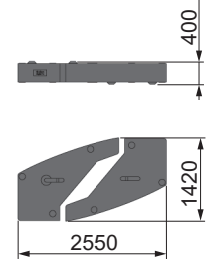

Boom components

Boom section 3 m
G = 1.6 t

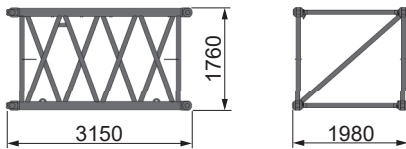

Boom section 6 m
G = 2.8 t

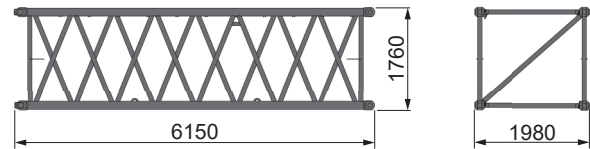

Boom foot section
G = 3.2 t

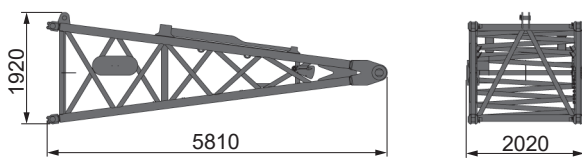

Upper boom section
G = 6.6 t

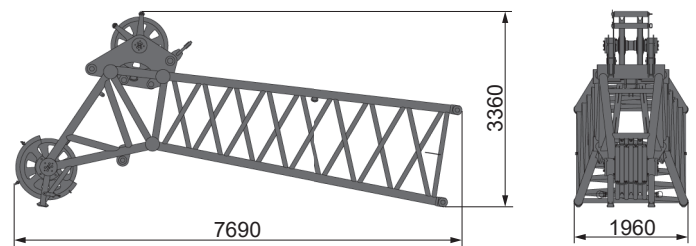



MC Line



BAUER Maschinen GmbH
BAUER-Strasse 1
86529 Schrobenhausen
Germany
Tel. +49 8252 97-0
bma@bauer.de
www.bauer.de

Design developments and process improvements may require the specification and materials to be updated and changed without prior notice or liability.

Illustrations may include optional equipment and not show all possible configurations.

These and the technical data are provided as indicative information only, with any errors and misprints reserved.